

A13-SOM512, board revision D

4Gb DDR3 SDRAM (256Mx16)

LED

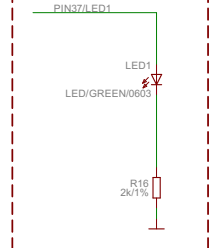

GPIO-1 EXTENSION

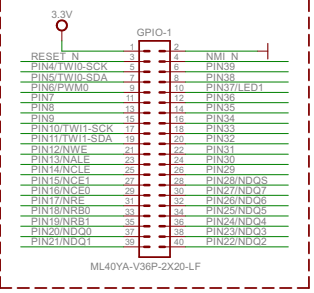

LCD EXTENSION

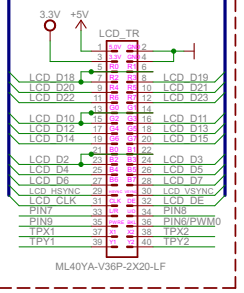

GPIO-2&3 EXTENSION

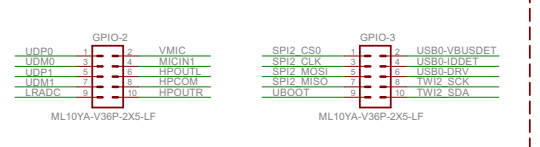

Debug UART

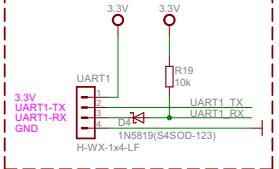

MicroSD

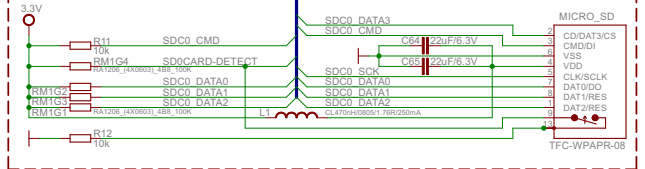

This is a proprietary hardware design. Hardware design files would not be distributed.

POWER SUPPLY CIRCUIT

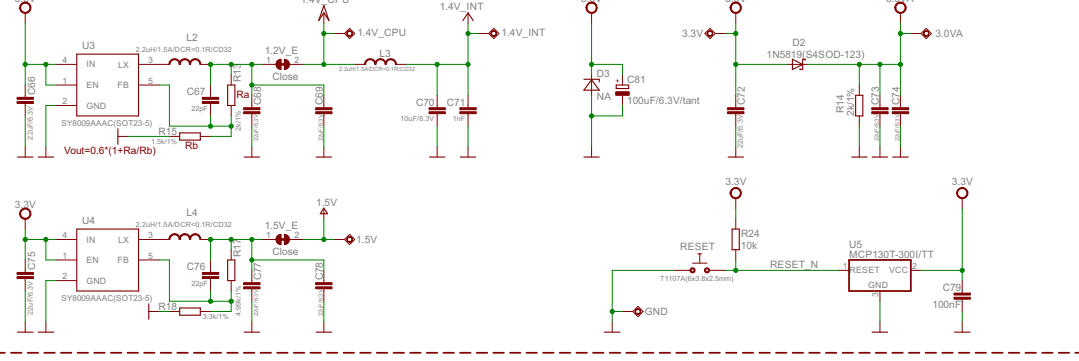

Button

