

PIC-WEB REV.B development board Users Manual



All boards produced by Olimex are ROHS compliant

Rev.C, March 2011

Copyright(c) 2011, OLIMEX Ltd, All rights reserved

INTRODUCTION

PIC-WEB is compact board with 65x60 mm size which is supported by Microchip's open source TCP-IP stack AN833. The board is designed with 64-pin high-performance, 1 Mbit Flash microcontroller with Ethernet - PIC18F67J60 and supports: SLIP, ARP, IP, ICMP, TCP, UDP, HTTP, DHCP, FTP. The Microchip stack is written very modular and flexible and you can enable or disable modules and supports dynamic web pages which give you the possibility to control all PIC resources remotely via FTP, HTTP, UDP, TCP etc. With this board you can implement web and ftp server, send e-mails and almost everything what the big servers do. The on board 1Mbit serial flash is available for data storage.

This board is designed to have Web page of no more than 128 kB. If you want a lot's of images in your application you can also host them on other server visible on the network where you have the PIC-WEB connected. The potential of the board is to generate a fluid communication between some specific sensors or actuators across a TCP/IP net including the controls of it.

The Microchip stack is an open source library, which is possible to modify and compile at any time. But you will probably need to modify it to your own needs. The board comes with an implemented WEB server and a web page that let you controls some of the features of the board. In this manual we'll learn about how to compile the TCP/IP stack to use it over the platform, the needed software, how to use the pre loaded web page, and how to upload your own web pages in the board.

This manual requires Microsoft Windows© OS because several software used here is windows compatible only.

BOARD FEATURES

- PIC18F67J60 microcontroller
- 1Mbit on board serial flash for web pages storage
- ICSP/ICD connector for programming and debugging with PIC-ICD2, PIC-ICD2-POCKET and PIC-ICD2-TINY.
- Reset button
- User event button
- Analogue trimmer potentiometer
- Thermistor for temperature monitoring
- RS232 driver and connector
- Complete web server and TCP-IP stack support as per Microchip's open source TCP-IP stack
- Power plug-in jack for +5VDC power supply
- Voltage regulator +3.3V and filtering capacitors
- status LED
- Extension header to connect to other boards
- PCB: FR-4, 1.5 mm (0,062"), solder mask, silkscreen component print
- Dimensions 60x65 mm (2.36x2.55")

ELECTROSTATIC WARNING

The PIC-WEB board is shipped in protective anti-static packaging. The board must not be subject to high electrostatic potentials. General practice for working with static sensitive devices should be applied when working with this board.

BOARD USE REQUIREMENTS

Cables: Depends on the used programming/debugging tool. It could be 1.8 meter USB A-B cable to connect [PIC-ICD2](#) or [PIC-ICD2-POCKET](#) to USB host on PC or Serial DB9 cable in case of [PIC-ICD2-TINY](#) or other programming/debugging tools. You will need a serial cable if not for programming, than for configuring the board. You will also need a Crossover Ethernet cable.

Hardware: Programmer/Debugger – most of Olimex programmers are applicable, for example [PIC-ICD2](#), [PIC-ICD2-POCKET](#), [PIC-ICD2-TINY](#) or other compatible programming/debugging tool.

!!!Warning!!! When you want to program this microcontroller with PIC-ICD2, PIC-ICD2-POCKET or PIC-ICD2-TINY, before connecting the programmer to your target board, you should first connect the programmer to your computer and open MPLAB. There, first from menu Configure – Select Device – choose the microcontroller you are about to program, then from menu Programmer – Select Programmer – choose MPLAB ICD 2, wait while MPLAB is downloading operation system, and after ICD2 is connected – check in menu Programmer – Settings – Power – there is option – Power target circuit from MPLAB ICD 2 – this option should be forbidden, you could not select it. Now it is safe to connect the programmer to your target board.

Software: PIC-WEB is tested with **MPLAB IDE v.8.14 + C18 compiler Free Standart EVAL Version** (www.microchip.com). TCP/IP stack (www.microchip.com). It is possible that the stack might not function properly if used with later versions of MPLAB IDE. You will also need a terminal program configured at 19 200 bps, 8N1 and no flow control.

PROCESSOR FEATURES

PIC-WEB board use CPU PIC18F67J60 from Microchip with these features:

- **Operating Frequency** - DC - 41.67 MHz
- **Flash program memory (bytes)** - 128k
- **Flash program memory (Instructions)** - 65532
- **SRAM data memory (bytes)** - 3808
- **Interrupt Sources** - 26
- **Ethernet TX/RX Buffer (bytes)** - 8192
- **I/O Ports** - A, B, C, D, E, F, G
- **I/O Pins** - 39
- **10-Bit A/D (ch)** - 11
- **Capture/Compare/PWM Modules** - 2
- **Enhanced Capture/Compare/PWM Modules** - 3
- **Serial Communications** - MSSP (1), Enhanced USART (1)
- **SPI**
- **Master I²C™**
- **Comparators** - 2
- **Timers 8/16-Bit** - 2/3
- **Resets (and Delays)** - POR, BOR, RESET Instruction, Stack Full, Stack Underflow, MCLR, WDT (PWRT, OST)
- **Instruction Set** - 75 Instructions, 83 with Extended Instruction Set Enabled

Ethernet Features:

- IEEE 802.3 compatible Ethernet Controller
- Integrated MAC and 10Base-T PHY
- 8-Kbyte Transmit/Receive Packet Buffer SRAM
- Supports one 10Base-T Port with Automatic Polarity Detection and Correction
- Programmable Automatic Retransmit on Collision
- Programmable Padding and CRC Generation
- Programmable Automatic Rejection of Erroneous Packets
- Activity Outputs for 2 LED Indicators
- Buffer:
 - Configurable transmit/receive buffer size
 - Hardware-managed circular receive FIFO
 - Byte-wide random and sequential access

- Internal DMA for fast memory copying
- Hardware assisted checksum calculation for various protocols
- MAC:
 - Support for Unicast, Multicast and Broadcast packets
 - Programmable Pattern Match of up to 64 bytes within packet at user-defined offset
 - Programmable wake-up on multiple packet formats
- PHY:
 - Wave shaping output filter
 - Loopback mode

Flexible Oscillator Structure:

- Selectable System Clock derived from single 25 MHz external source:
 - 2.78 to 41.67 MHz
- Internal 31 kHz Oscillator
- Secondary Oscillator using Timer1 @ 32 kHz
- Fail-Safe Clock Monitor:
 - Allows for safe shutdown if oscillator stops
- Two-Speed Oscillator Start-up

Peripheral Highlights:

- High-Current Sink/Source: 25 mA/25 mA on PORTB and PORTC
- Five Timer modules (Timer0 to Timer4)
- Four External Interrupt pins
- Two Capture/Compare/PWM (CCP) modules
- Three Enhanced Capture/Compare/PWM (ECCP) modules:
 - One, two or four PWM outputs
 - Selectable polarity
 - Programmable dead time
 - Auto-shutdown and auto-restart
- Up to two Master Synchronous Serial Port (MSSP) modules supporting SPI (all 4 modes) and I2C™ Master and Slave modes
- Up to two Enhanced USART modules:
- Supports RS-485, RS-232 and LIN 1.2
 - Auto-wake-up on Start bit
 - Auto-Baud Detect
- 10-Bit, up to 16-Channel Analog-to-Digital Converter module (A/D):
 - Auto-acquisition capability
 - Conversion available during Sleep

- Dual Analog Comparators with Input Multiplexing

Special Microcontroller Features:

- 5.5V Tolerant Inputs (digital-only pins)
- Low-Power, High-Speed CMOS Flash Technology:
 - Self-reprogrammable under software control
- C compiler Optimized Architecture for re-entrant code
- Power Management Features:
 - Run: CPU on, peripherals on
 - Idle: CPU off, peripherals on
 - Sleep: CPU off, peripherals off
- Priority Levels for Interrupts
- 8 x 8 Single-Cycle Hardware Multiplier
- Extended Watchdog Timer (WDT):
 - Programmable period from 4 ms to 134s
- Single-Supply 3.3V In-Circuit Serial Programming™ (ICSP™) via two pins
- In-Circuit Debug (ICD) with 3 Breakpoints via two pins
- Operating Voltage Range of 2.35V to 3.6V (3.14V to 3.45V using Ethernet module)
- On-Chip 2.5V Regulator

BLOCK DIAGRAM

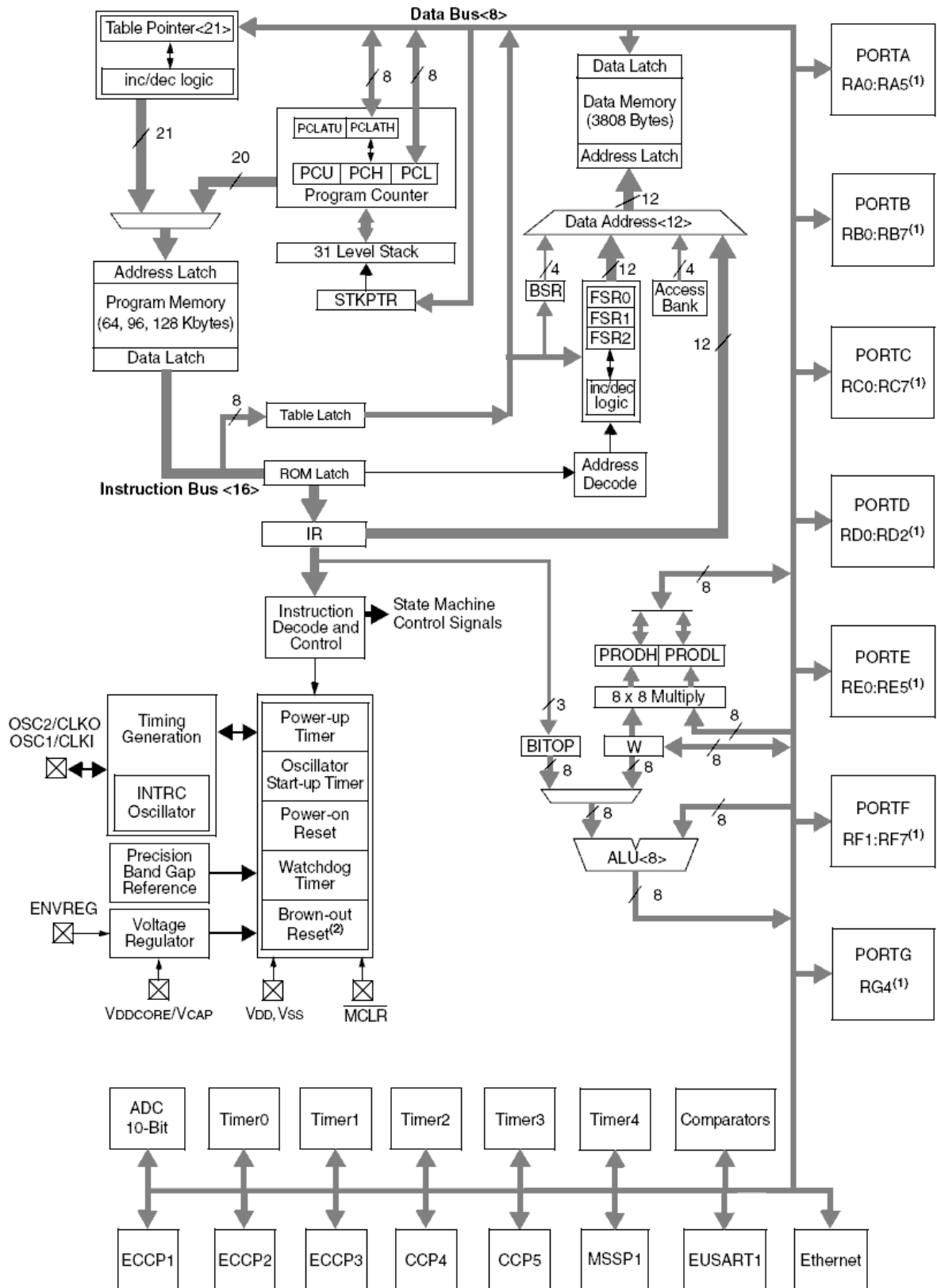

Note 1: BOR functionality is provided when the on-board voltage regulator is enabled.

MEMORY MAP for PIC18F67J60

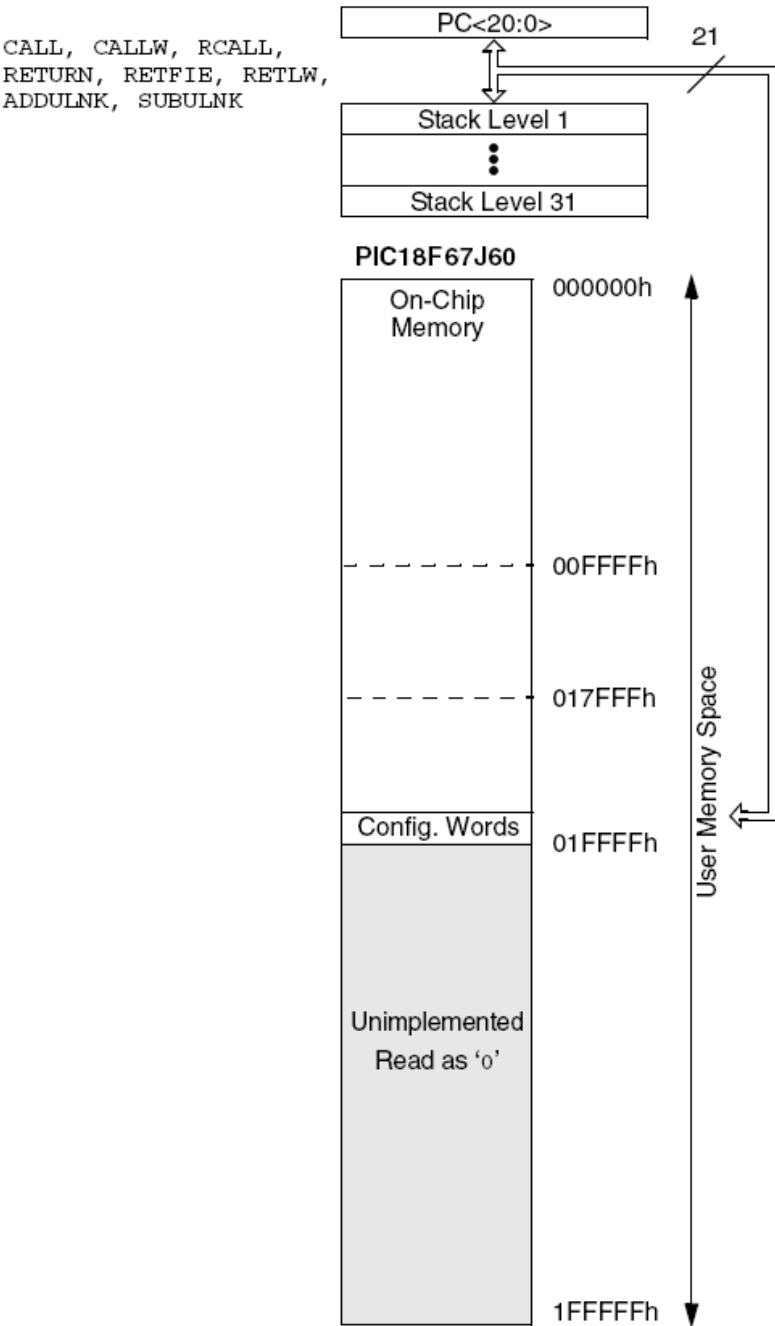

Note: Size of memory area is not to scale. Size of program memory area is enhanced to show detail.

BOARD LAYOUT

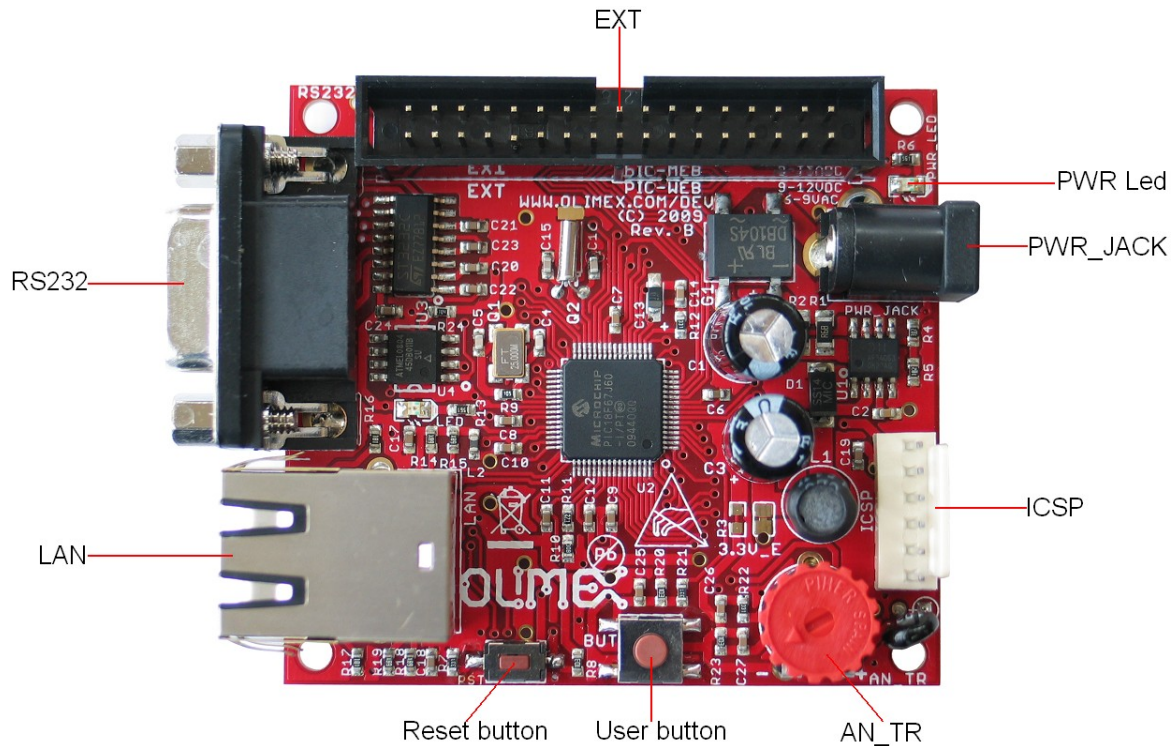

POWER SUPPLY CIRCUIT

PIC-WEB can take power from two sources:

- PWR_JACK where (9-12) VDC is applied by external power source.
- EXT-20 pin VIN with the same voltage range.

The board power consumption is: about 130 mA with all peripherals and MCU running at full speed.

RESET CIRCUIT

PIC-WEB reset circuit is made with R8 (10k) pull-up, R7 (330R) serial resistor and RST button.

Although on the schematic is made provision for external reset through EXT-16 pin. Manual reset is possible by the RST button.

CLOCK CIRCUIT

Quartz crystal 25 MHz is connected to PIC18F67J60 clock in and clock out.

Quartz crystal 32.768 KHz is connected to PIC18F67J60 T1OSO and T1OSI pins for it's internal Real Time Clock.

JUMPER DESCRIPTION

3.3V_E



This jumper, when closed, enables 3.3V board power supply.
Default state is closed.

INPUT/OUTPUT

One User button with name **BUT** - connected to PIC18F67J60 pin 3 (RB0/INT0/FLT0);

Status red LED with name **LED** connected to PIC18F67J60 pin 44 (RB4/KBI0).

Power supply red LED with name **PWR** - indicates that external power source is applied and board power supply is applied.

One trimmer **AN_TR** is connected to PIC18F67J60 pin 15 (RF3/AN8).

EXTERNAL CONNECTORS DESCRIPTION

ICSP

Pin #	Signal Name
1	RST
2	+5V
3	GND
4	PGD
5	PGC
6	PGM - NC

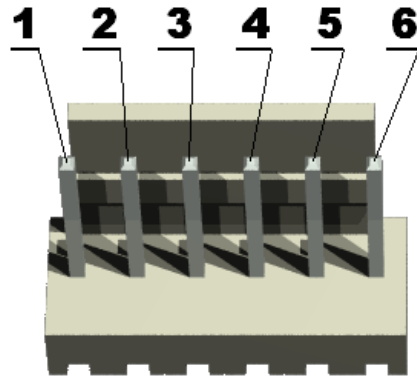

RS232

Pin #	Signal Name
1	NC
2	T1OUT
3	R1IN
4	NC
5	GND
6	NC
7	R2IN
8	T2OUT
9	NC

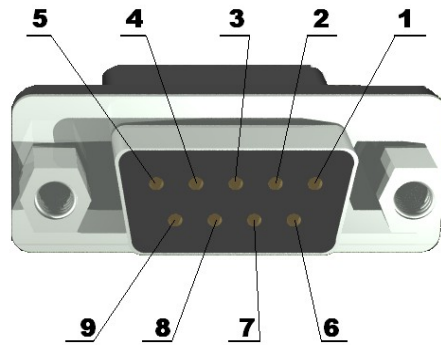

PWR JACK

Pin #	Signal Name
1	Power Input
2	GND

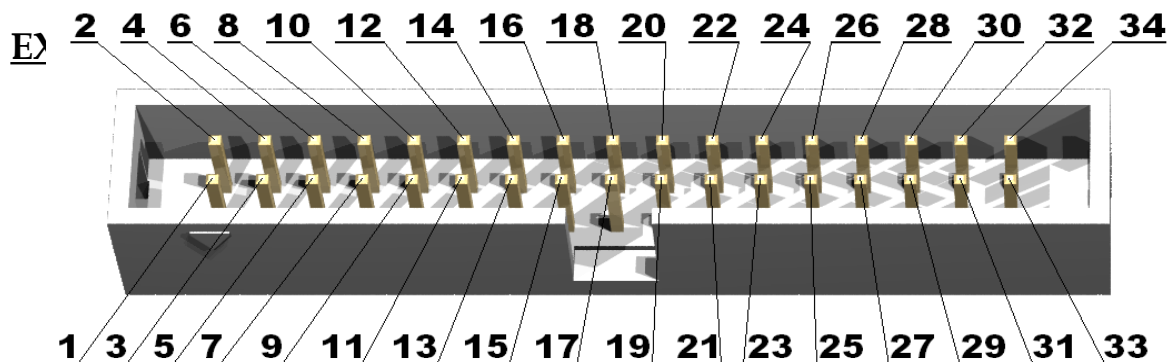
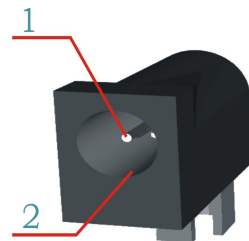

Pin #	Signal Name	Pin #	Signal Name
1	RA2/AN2/VREF-	2	RA3/AN3/VREF+
3	RA4/T0CKI	4	RA5/AN4
5	RE0/P2D	6	RE1/P2C
7	RE2/P2B	8	RC2/ECCP1/P1A
9	RD0/P1B	10	RD1/ECCP3/P3A
11	RD2/CCP4/P3D	12	RB1/INT1
13	RB2/INT2	14	RB3/INT3
15	RB5/KBI1	16	RST
17	+3,3V	18	+3.3V
19	GND	20	VIN
21	RE3/P3C	22	RE4/P3B
23	RE5/P1C	24	RF1/AN6/C2OUT
25	RF2/AN7/C1OUT	26	RF5/AN10/CVREF
27	RF6/AN11	28	RG4/CCP5/P1D
29	CTS	30	RTS
31	NC	32	NC
33	3.3VA	34	GND A

LAN

Pin #	Signal Name
1	TPOUT+
2	TPOUT-
3	3.3v
4	NC
5	NC
6	NC

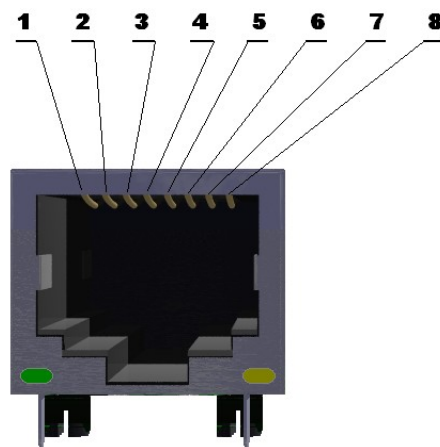

7	TPIN+
8	TPIN-

LED	Color	Usage
Right	Yellow	Activity
Left	Green	100MBits/s (Half/Full duplex)

MECHANICAL DIMENSIONS

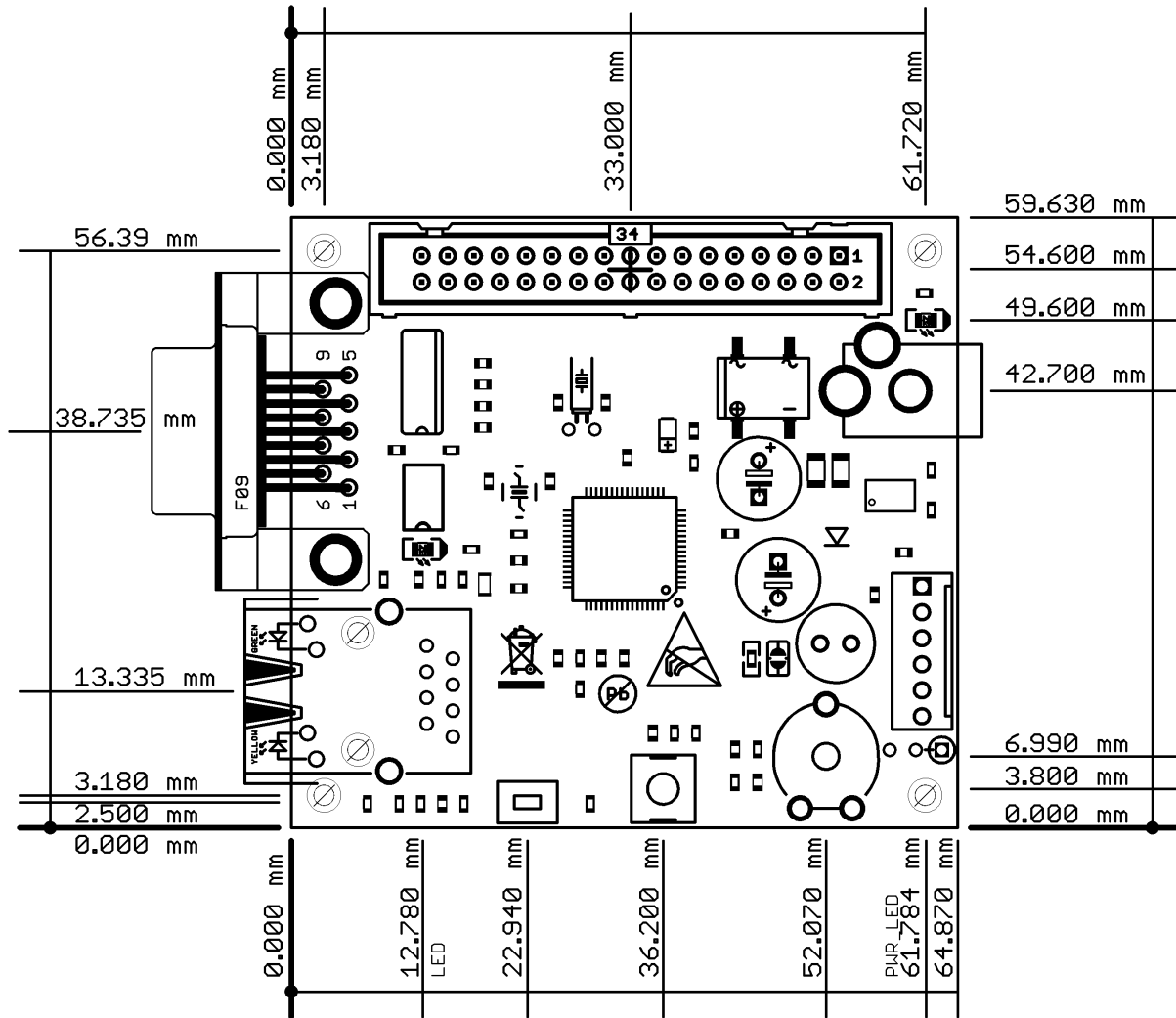

Connecting and testing the board

The PIC-WEB comes with a default code and web server that you can test in a couple of simple steps. First of all you have to configure the Ethernet port to be able to work on your local network. That is possible through the MCHPStack Configuration Console.

Using the PIC-WEB configuration console

It's possible to modify the network configuration using the configuration console on the serial port, allowing a successful operation on your local network. Using the configuration console you can change the PIC-WEB IP address for example.

To access to the console menu is necessary a serial DB9 cable, to connect the board serial port to one available COM port on your computer. Then you will need to connect the board using a software like windows HyperTerminal. You can use HyperTerminal because it is included on almost all windows machine. It is located in Start menu → All Programs → Accessories → Communications. Double click on HyperTerminal and then choose the COM port where the board is connected.

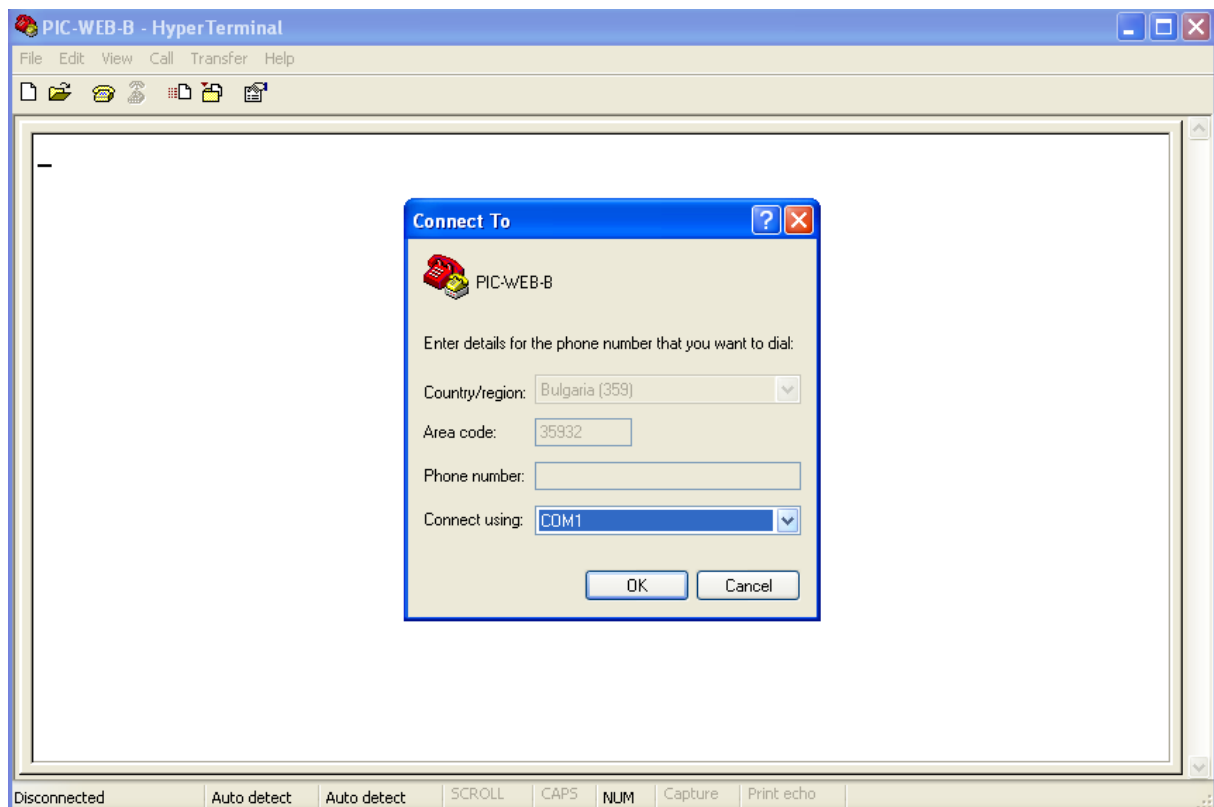

Now is necessary to configure the serial connection to:

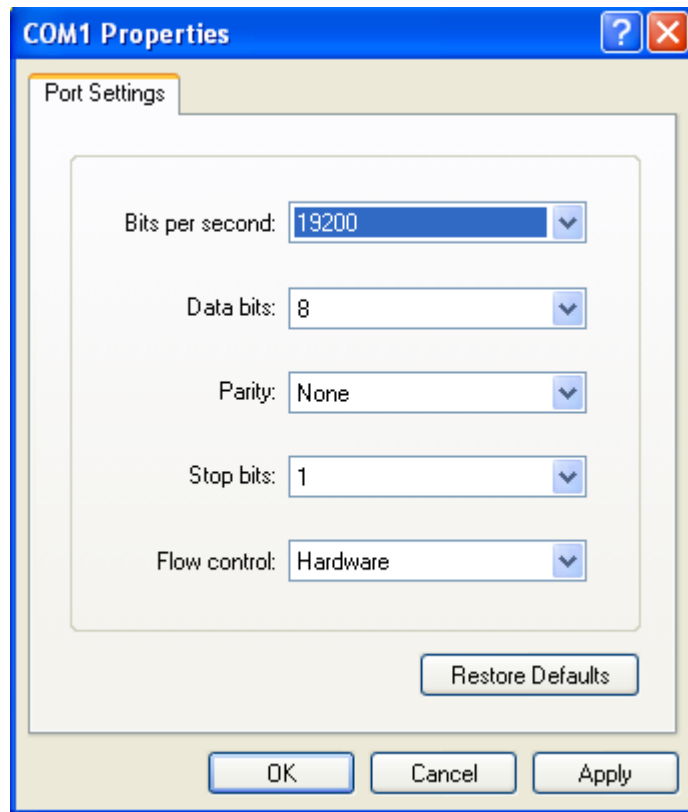

These are the basic steps to configure the connection. If you want to see what you are typing you should set the checkbox "Echo typed characters locally" in File->Properties->Settings->ASCII Setup. Then save the connection for later use.

After this setup the connection with the PIC-WEB should be ready, but the console will not show anything!. That's because the board is not running on configuration mode. To run on that mode you just need to push the "BUT" button on the board. Keep it pressed while you push the "RST" button.

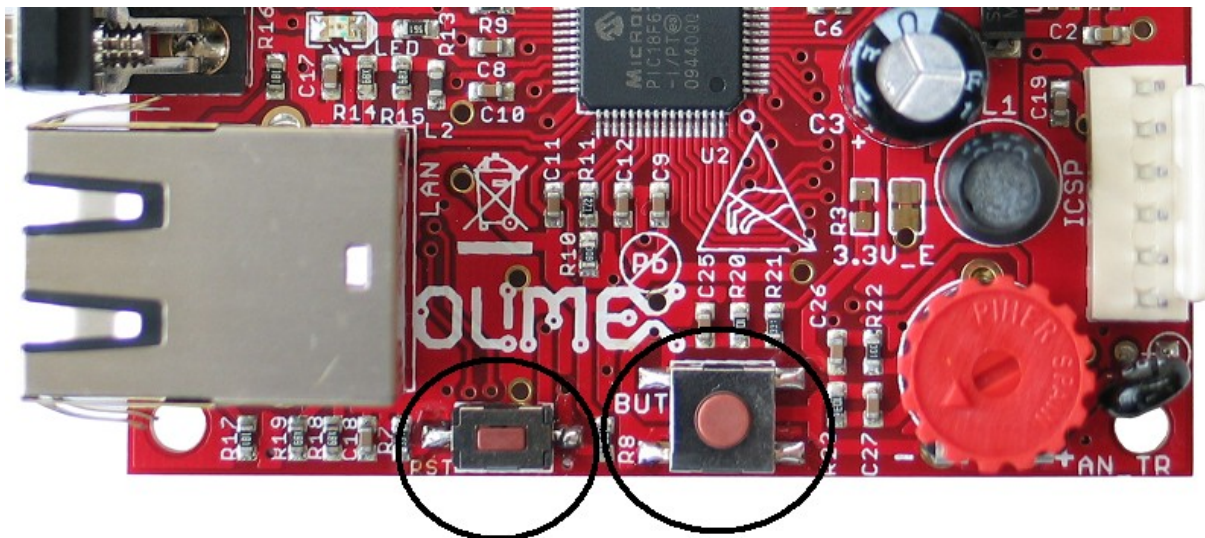

A menu will immediately appear on HyperTerminal showing following options:

```
PIC-WEB-B - HyperTerminal
File Edit View Call Transfer Help
Microchip TCP/IP Config Application (v5.00, May 21 2009)
1: Change serial number:          65535
2: Change host name:             PIC-WEB
3: Change static IP address:     192.168.0.30
4: Change static gateway address: 192.168.0.1
5: Change static subnet mask:    255.255.255.0
6: Change static primary DNS server: 192.168.0.1
7: Change static secondary DNS server: 0.0.0.0
8: Disable DHCP & IP Gleaning:    DHCP is currently enabled
9: Download MPFS image.
0: Save & Quit.
Enter a menu choice: _
Connected 00:02:18  Auto detect  19200 8-N-1  SCROLL  CAPS  NUM  Capture  Print echo
```

The third option allow you to change the board IP number. Just type 3, then enter the new IP compatible with your local network configuration. After that push ENTER and return to the main menu again.

Now you must configure the other network parameters: gateway and subnet mask or if you prefer you can enable the DHCP to get the configuration from your router. The first and the second options are not used in this manual. At this moment we will only use the on-board default page.

The last option saves the configuration and restarts the PIC-WEB.

For testing purposes you can connect the board directly to your computer with a crossover ethernet cable , configure the board with 192.168.0.32 address, 192.168.0.1 gateway, disable DHCP (option 6) and configure the Ethernet adapter on your computer with 192.168.0.31 and the same gateway. Here is an example of windows configuration:

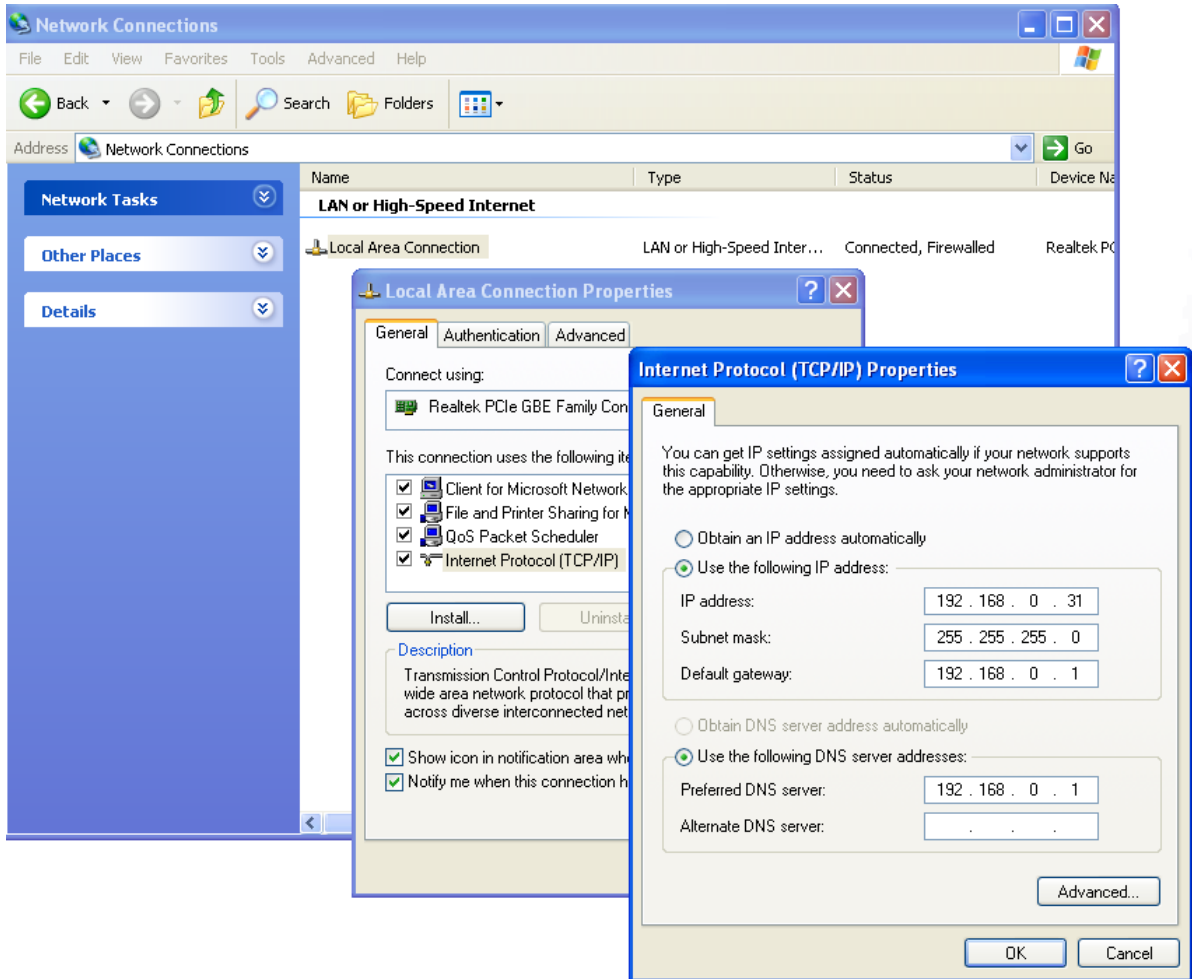

This configuration will let you test the board directly from your PC but isn't too useful. The fun stuff begins when you have the PIC-WEB connected to internet. Just imagine your sensor monitor project, but now you will be able to see the information anywhere just browsing the address of the board!

Test WEB page:

As it was mentioned above, the PIC-WEB board has an embedded web server and a demo page. The page shows some of the features of the board and it have a link to Olimex's PIC-WEB information page.

To access the demonstration page, the server must be accessible from the computer. The default IP address of the board is 192.168.0.30, and 192.168.0.1 is the gateway. Those values must been set to work with your net. In this manual we have set IP address of the board to 192.168.0.32. Then you can get the page with any web browser writing the IP address of the board on the address bar.

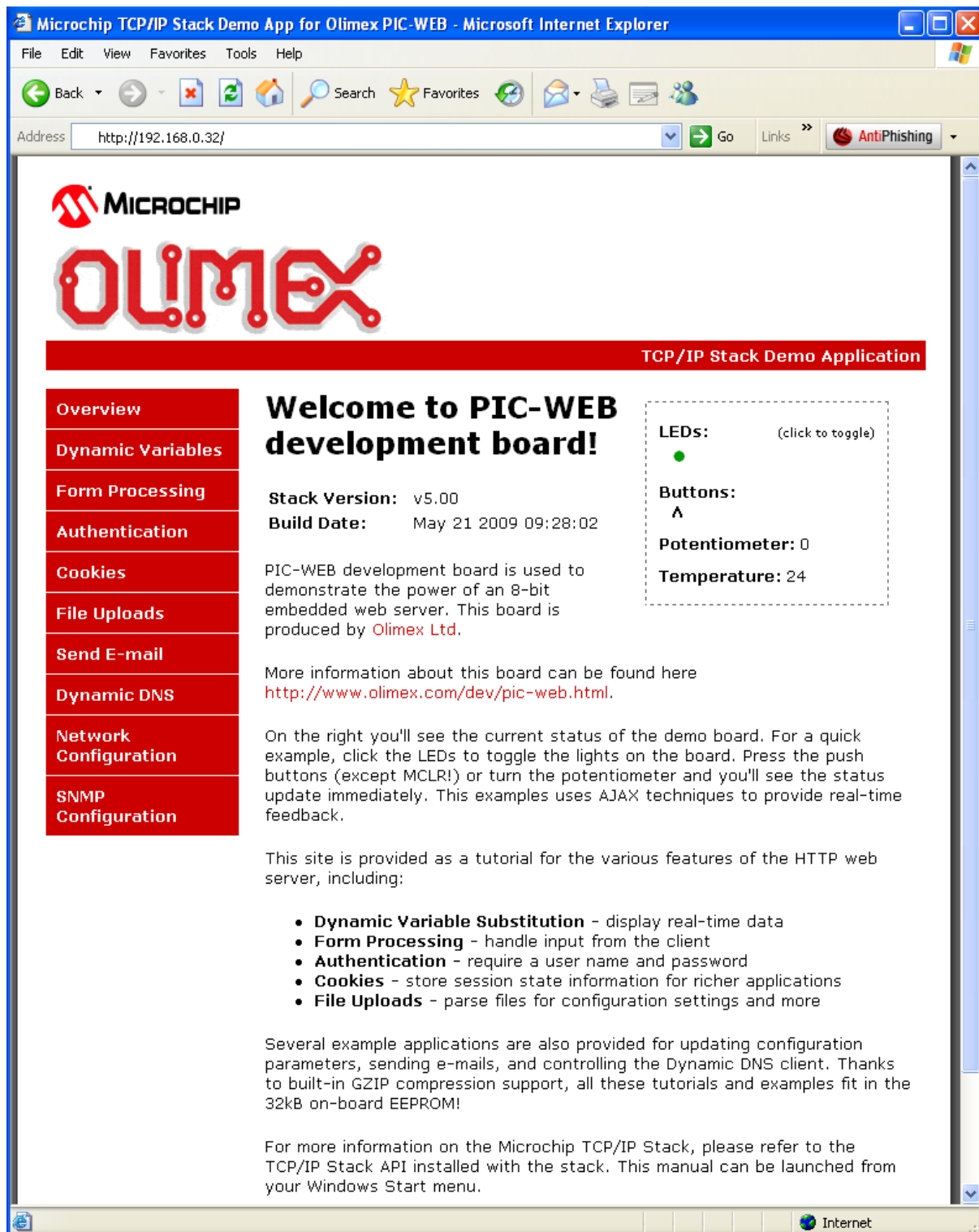

At the picture above, you can see the default page that you must get. It shows the temperature of the on-board thermistor, the status of the button BUT, the value of the potentiometer, the status of the LED and so on.

To toggle the status LED of the board (PIC-WEB) you can click on the green dot under the caption "LEDs:". By clicking on this dot you are changing the state of the pin, see how the led switch on or switch off.

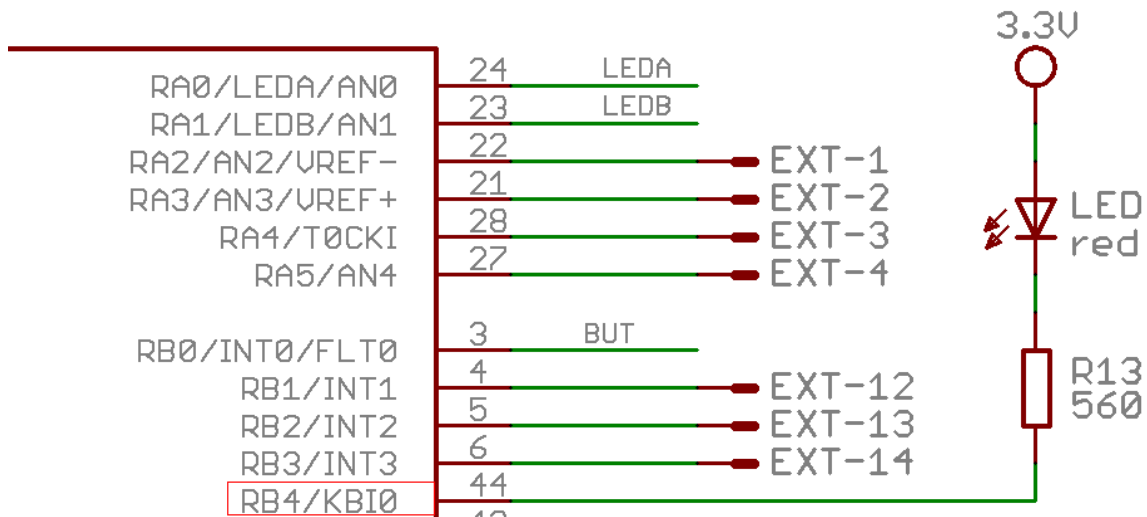

At the page you can also see some values of the PIC-WEB sensors and buttons:

- Buttons:
- Potentiometer:
- Temperature:

“Potentiometer” shows a measurement from the PIC A/D connected to a 10KΩ potentiometer on the board, you can freely change that potentiometer position and check how the measurement changes.

“Temperature” shows the value of the temperature sensed by the thermistor in the board connected to another A/D port of the PIC18F67J60.

“Buttons” shows the state of the on-board button. It is “^” while the button is not pressed and “_” if it is pressed.

Uploading pages to the server

There are 2 easy ways to upload pages to the server, but you will always need to convert the files you want to upload in a MPFS file format. One other way is to include the web page on the source code and link it in a project, but if we did it in this way we won't use the EEPROM included in the platform wasting program memory, that is reason this method will not be included in this manual.

Microchip File System (MPFS)

The implemented HTTP server uses the MPFS simplified file system to store the pages on the embedded system. That is why it is necessary to transform the files to that file system before uploading them. This is done using a program included in PIC-WEB software called MPFS2.exe.

Let's create a simple “Hello World” page and upload it in to the HTTP server.

First of all it's necessary to create a directory on your PC where to put the files you want to upload to the web server. The “index.htm” is a must have file because that is the default page read by the server. We will also upload a picture “olimex.gif” (get it from the site for example). The code of the page is the simplest possible:

```
<HTML>
<HEAD>
<TITLE>Hello World</TITLE>
</HEAD>
<BODY>
    <p align="center">
        
    </p>
    <font face="Arial" size="10"><p align="center">
        <b>Hello World!!!</b>
    </p></font>
</BODY>
</HTML>
```

Next thing to do is just start the MPFS2.exe utility and set up the required fields. Here is a screenshot of one possible configuration:

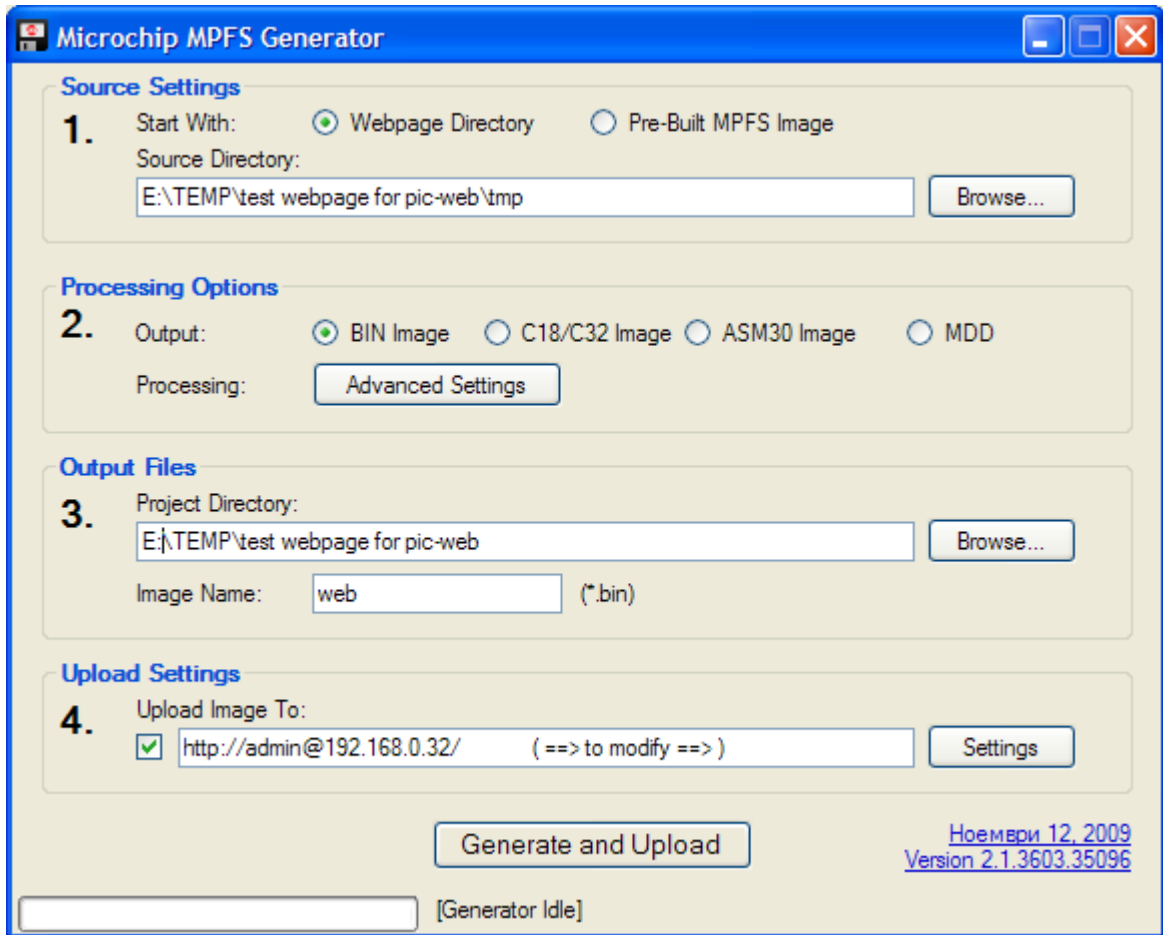

A very handy feature of the utility is point 4, which may be used to automatically upload the image to the board after a successful conversion. Enter the IP of your board and leave the other fields

at defaults. Press the 'Generate and Upload' and wait for your new image to be generated and uploaded. This is a sample of the result of a successful upload:

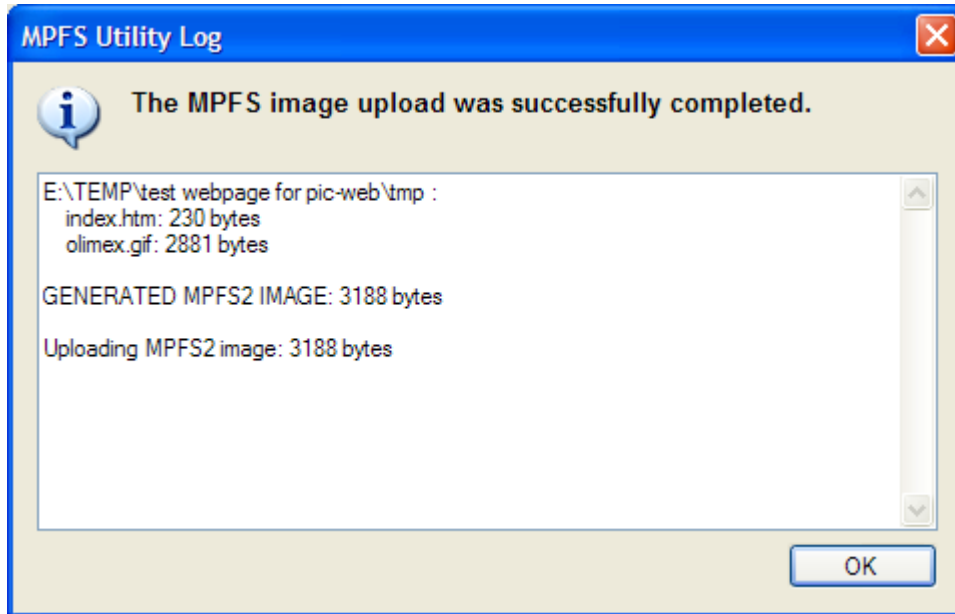

Please note that an image file (in this case web.bin) is generated and may be used later if you select the 'Pre-built MPFS image' radio button at the top of the utility program window.

Another way to upload an image for the web server is through the web server itself. You will need a pre-built image (yes, should be built by the MPFS2 utility again) somewhere in your PC's file system. In your favourite browser type the IP of the board with the following path:

<http://192.168.0.32/mpfsupload>

Here is a screenshot of what you will see:

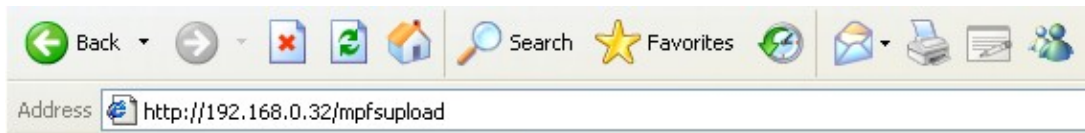

MPFS Image Upload

No file chosen

Now point to the image file and press 'Upload'. Sit back and relax while the upload takes place and then navigate to the home page to behold the new page just uploaded.

The result will be:



Installing the development environment

The web page that we wrote in last chapter obviously doesn't have any utility for any application at all. The idea of the PICWEB is to have control of the PIC18F67J60 features over the net using dynamics web pages or others TCP/IP protocols included in the Microchip Stack. In this manual we will explain how to create a dynamic web page, but this isn't the limit of the PIC-WEB and the TCP/IP Stack, you can get further to reach the full capacity of this platform and manage other protocols of network communication between the PIC microcontroller and any client or server in the network.

The PIC-WEB comes with compiled and installed software that can also be downloaded from Olimex web page, this software is based on two basics components from Microchip plus a C compiler. These components are the Microchip AN833 TCP/IP Stack, Microchip MPLAB IDE the PIC microcontroller software development platform and a compatible compiler that can be Microchip C18 this last one isn't free but Microchip have a free standard eval version that we can use with limited support

but it is absolutely functional to our purpose. There is other compatible compiler the Hi-Tech PICC-18. We'll choose the Microchip compiler for this manual.

It will be also necessary to continue with this manual to have an ICSP programmer for the PIC18. Is advisable that this programmer be compatible with MPLAB IDE and would be better to have

debugger too, but the last one isn't necessary. You can upload programs to the PIC-WEB with any programmer and software compatible with PIC18 like Olimex's PIC-ICD2-POCKET programmer.

MPLAB Integrated Development Environment

MPLAB IDE is free software distributed by Microchip that includes a toolset for development of PIC microcontroller applications for windows OS. It basically integrate transparently other modules like C18 or PICC-18 compilers that strengthen the functionality of MAPLAB and let us program in C language by example.

Installation: After you have downloaded MAPLAB IDE from Microchip page, you must decompress it in any directory and execute the installation file (something like "Install_MP760a.exe") following the typical windows software installation.

Complete installation is recommended to avoid compatibility troubles in the project.

MPLAB C18 Compiler

MPLAB C18 is a C compiler intended for the PIC18 family from Microchip. In our case is the needed compiler because the PIC-WEB platform uses the PIC18F67J60. This software converts C code into PIC18 machine code and link them together into a "*.HEX" file with the proper memory mapping for the microcontroller just ready to be programmed on it.

Installation: After downloading you must execute the installation file (something like "MPLAB-C18-Std-Eval-v3_34.exe") and follow the usual steps, but now you need to take care on some stuff. First of all, is advisable to install it in the default directory (C:\MCC18) and add the path environment variables, large directories names can bring troubles with linker. Second is necessary to install MPLAB C18 after MPLAB IDE installation and check the boxes that associate C18 to MPLAB IDE.

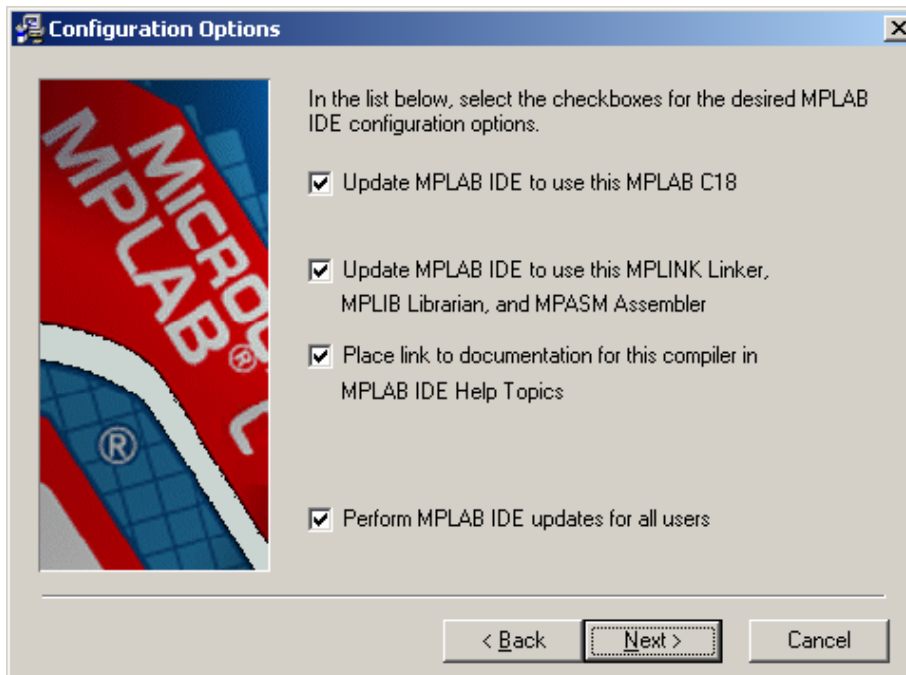

After these steps you are able to develop C programs and compile it using MPLAB environment.

Microchip AN833 TCP/IP Stack

The Stack is an application developed by Microchip for been used in its PIC18 family and intended for both Microchip C18 and Hi-Tech PICC-18 compilers. You can download it from microchip page and we encourage you to download its manual for reference purpose.

Programmer

There are several ways to program a PIC, but the easiest and proper way to program the PIC-
WEB is using a compatible programmer with an ISCP connector and compatible with MPLAB IDE.
For this purpose it will be used an USB programmer compatible with MPLAB ICD 2 sold by Olimex,
the PIC-ICD2-POCKET.

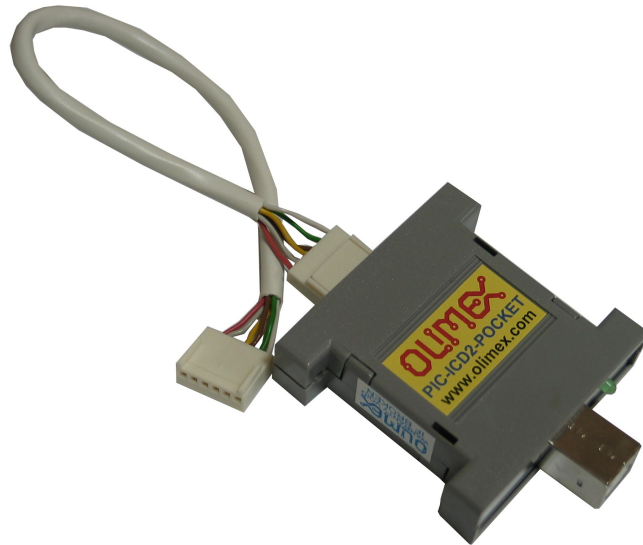

PIC-ICD2-POCKET: to use this programmer first of all you must have it connected to the PC
through a USB cable. Then you must select in MPLAB IDE – Configure → Select Device... A new
window will appear. Here you should select your device – PIC18F67J60. Here is a screenshot of this
window:

Then you must select in MPLAB IDE – Programmer → Select Programmer → MPLAB ICD 2.

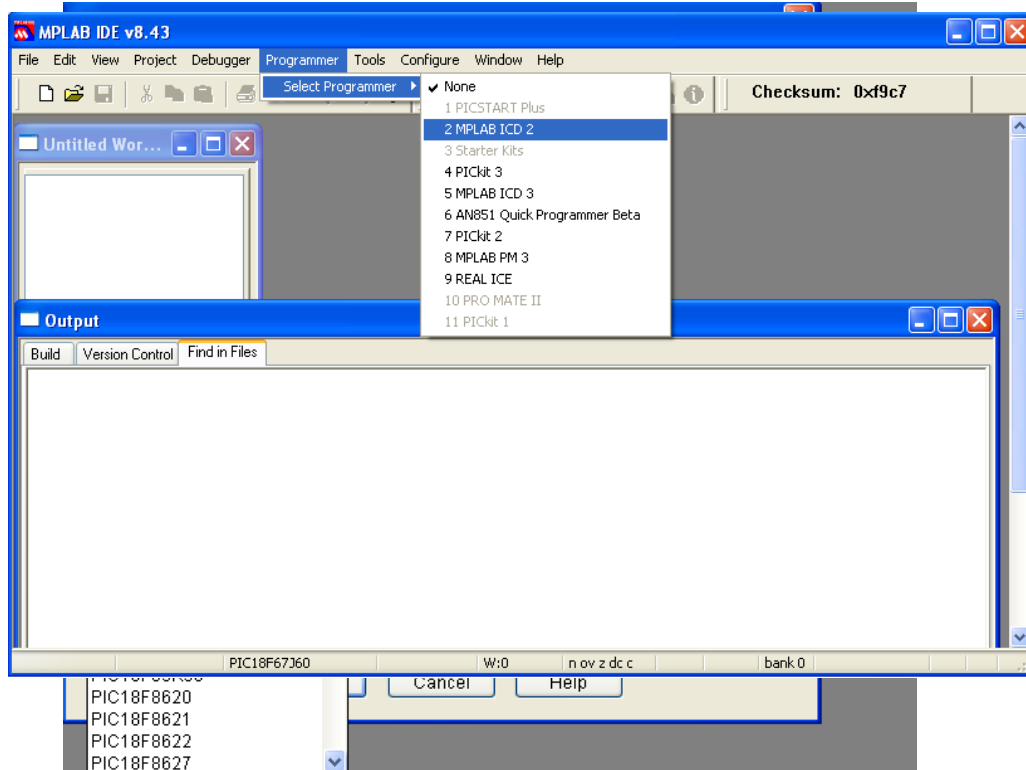

Wait while MPLAB is downloading operation system, and after ICD2 is connected – check in
menu Programmer – Settings – Power – there is option – Power target circuit from MPLAB ICD 2 –

this option should be forbidden, you could not select it. Now it is safe to connect the programmer to your target board through an I2C cable. The PIC-WEB should be connected to the power supply.

If you have something already compiled, you can open the "*.hex" file and then program it to the PIC-WEB. Just importing the "*.hex" file in File → Import menu. If you don't have something already compiled, you can use some of the "*.hex" files offered by Olimex Ltd. To use them you should first download TCP/IP stack library v5.0 from Microchip's site or some other place of your choice. Since this version will not be eternally distributed from Microchip, please ask for assistance from Olimex if you are experiencing difficulties finding the stack files.

Olimex's board has a few hardware differences compared to the boards supported by the default distribution of the TCP/IP stack. Convenient enough there is a patch you need to apply to the standard installation of the stack demos. Download pic-web_revB_patch_V5_0 (2).zip from <http://www.olimex.com/dev/>. Then unzip it in the 'Microchip Solutions' directory where the TCP/IP stack source code resides (this is the directory that contains the subdirectories "Internet Bootloader App", "Internet Radio App", "Microchip", "TCPIP Demo App", "TCPIP WebVend App") and follow the instructions from the .\PIC_WEB_RevB_Patch\patch\README.txt.

After you have done everything correctly you will have ready to use "*.hex" files.

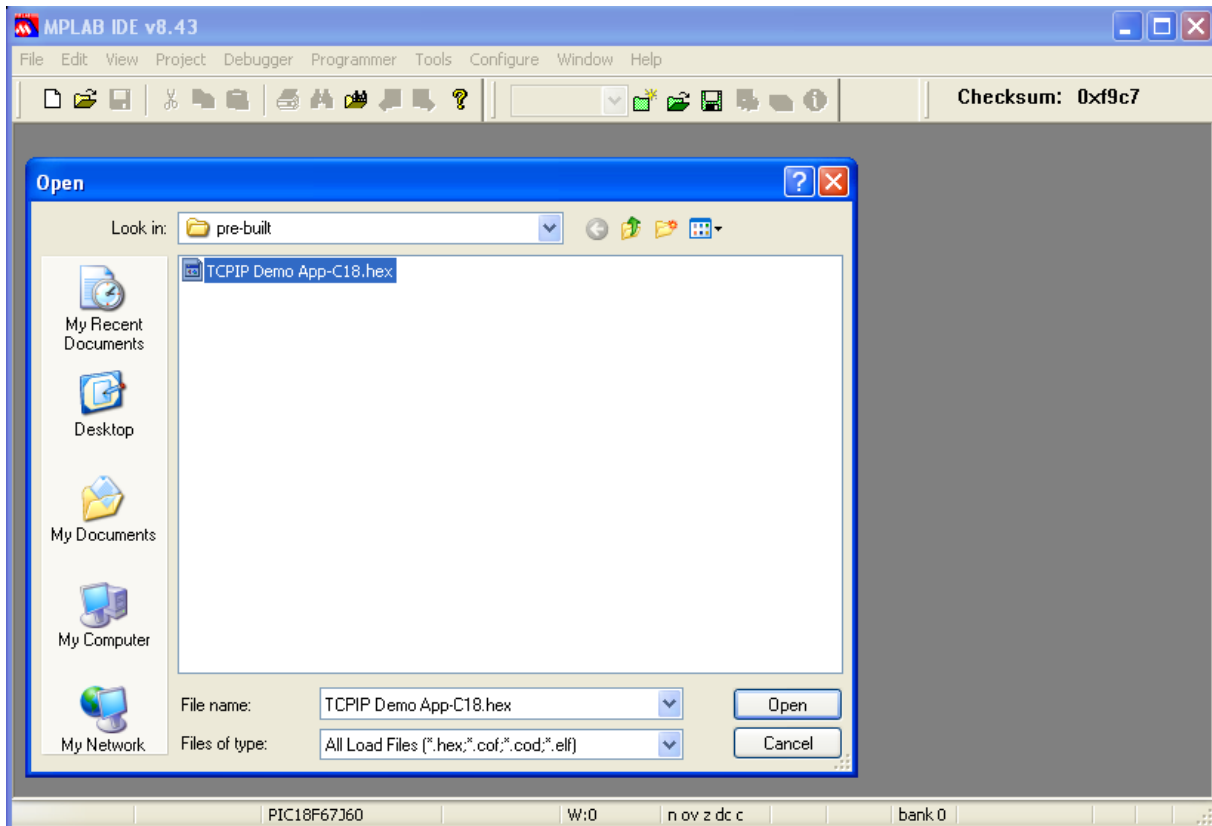

For programming the PIC just push the program button on the tools or selecting the menu Programmer → Program.

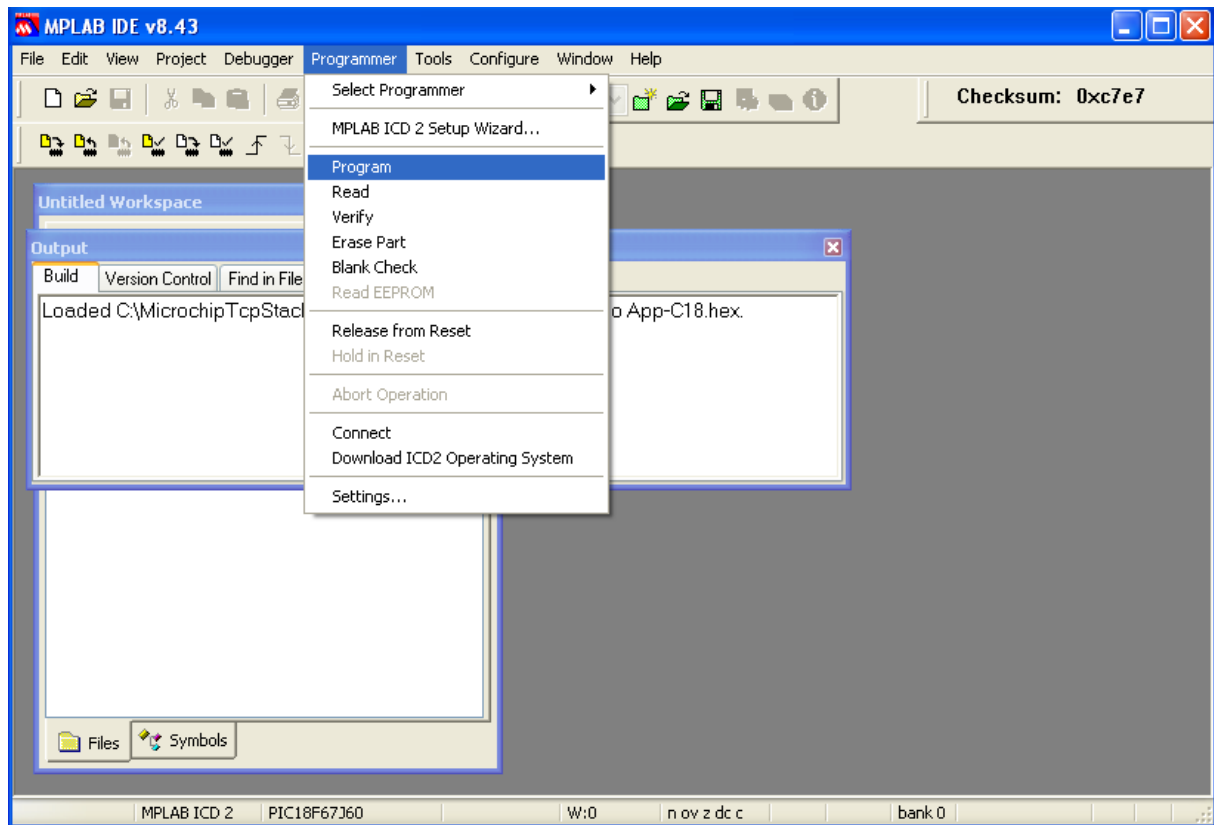

PIC-WEB Software

If you haven't downloaded the PIC-WEB software distributed by Olimex and TCP/IP stack library v5.0 from Microchip's site or some other place of your choice, now is time to do that.

After downloading the necessary PIC-WEB software and executing the instructions in "README.txt" file, you will have a working demo. Open this workspace '.\TCPIP Demo App\TCPIP Demo App-C18.mcw'.

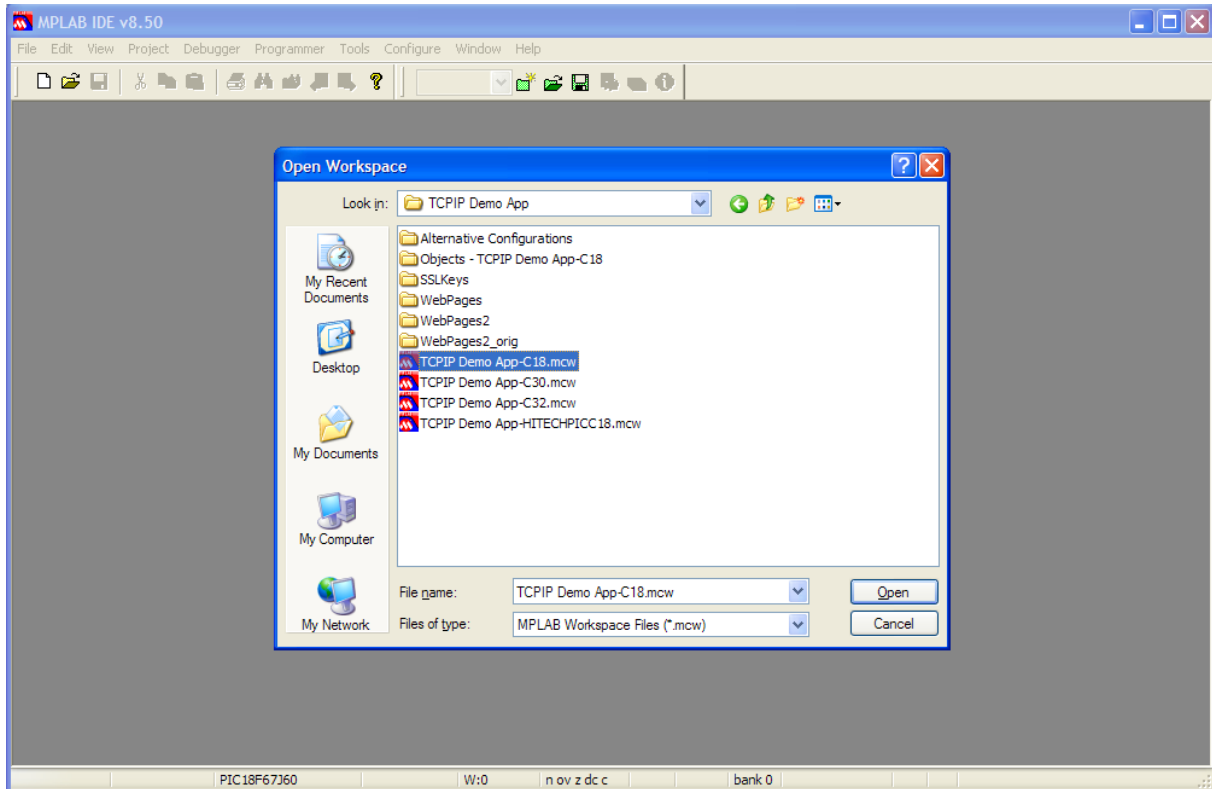

Before compiling check that the necessary include directories are well configured to use C18, those are:

- Include Search Path: **MCC18\h**
- Library Search Path: **MCC18\lib**
- Linker-Script Search Path: **MCC18\lib**

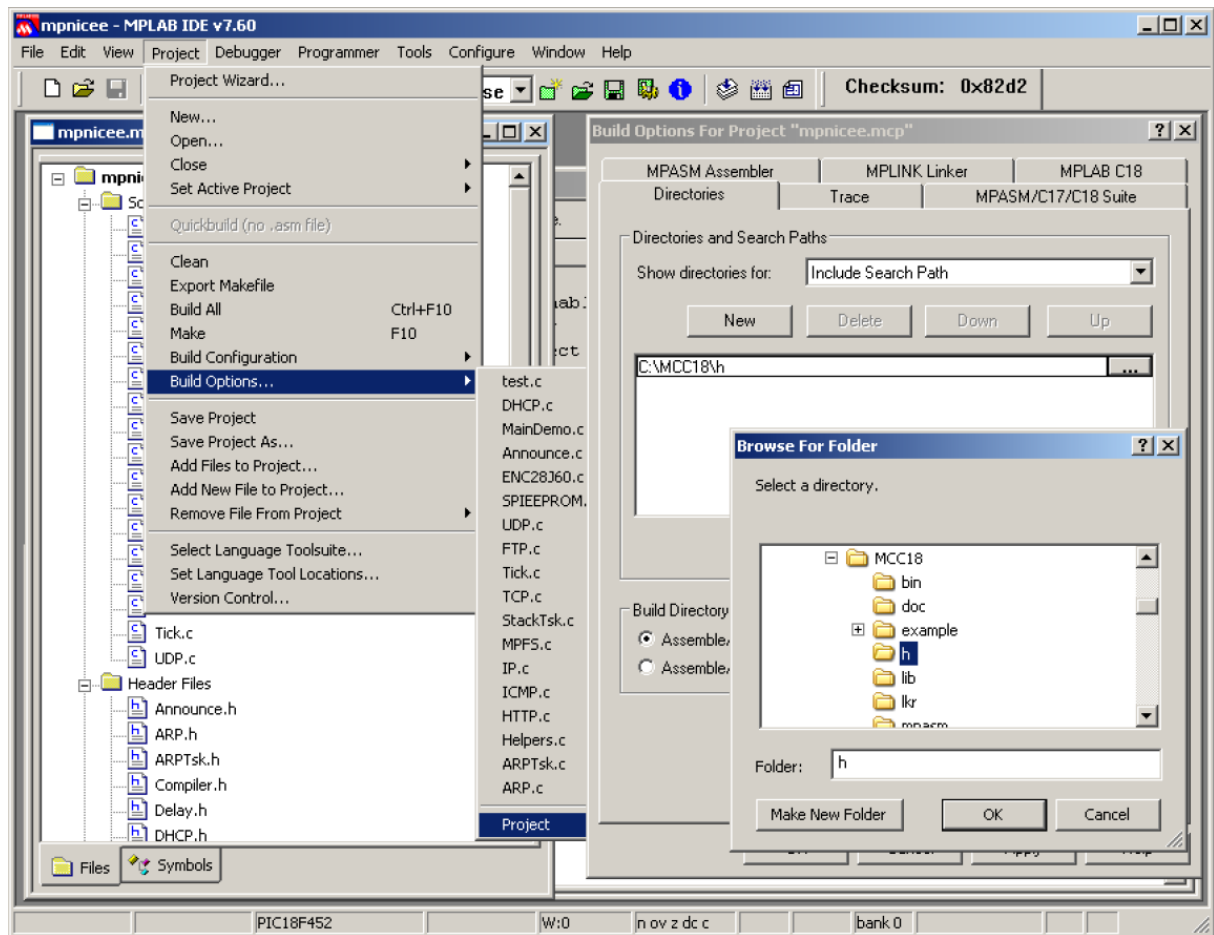

Now is time to compile! If there aren't bad configuration the compilation must be successful, that means that you have to get the "BUILD SUCCEEDED" message on the output window.

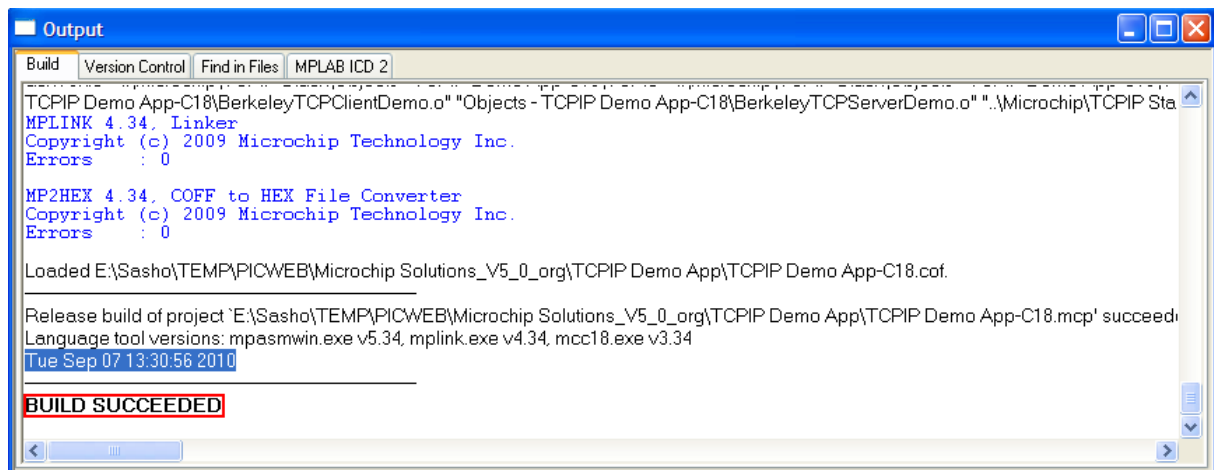

Note: the version of the MPLAB IDE that you are using can change the last explanation, newer version will appear since this manual was written or you can have an old one, that's means that the software configuration steps can change a little but the main idea is the same. Don't hesitate if it doesn't work on the first time, just keep trying isn't complicate.

Dynamic Web Pages Creation

For dynamic web pages creation you should refer to .\Microchip\Help\TCPIP Stack Help.chm at your computer. There you can find all the necessary information, following the way, shown at the screenshot below:

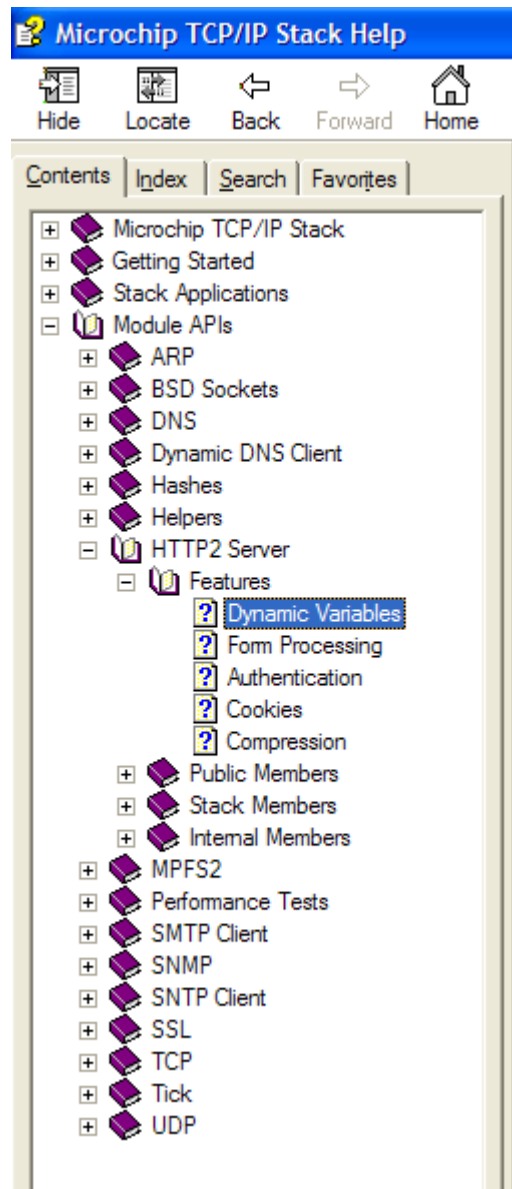

Restore procedure:

If you want to restore Olimex's original software you should program PIC18F67J60 with .\PIC_WEB_RevB_Patch\pre-built\TCPIP Demo App-C18.hex from MPLAB IDE.

After you have load this "*.hex" file, you should open .\PIC_WEB_RevB_Patch\pre-built\Microchip Ethernet Discoverer.exe. Click on the button "Discover Devices" and the IP address of PIC-WEB will be discovered (for example - 192.168.0.238). Note that your LAN has to have DHCP server. In your browser type the IP of the board with the following path:

<http://192.168.0.238/mpfsupload>

Here is a screenshot of what you will see:

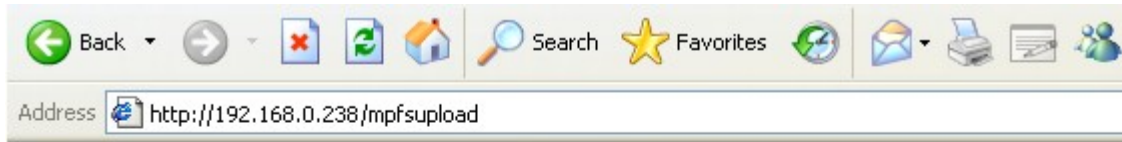

MPFS Image Upload

No file chosen

Click on the button "Choose File" to select the "*.bin" file you are about to upload. Select the image file in directory .\PIC_WEB_RevB_Patch\pre-built\MPFSImg2.bin and press 'Upload'. Sit back and relax while the upload takes place and then navigate to the home page to behold the page just uploaded.

Now your PIC-WEB is with Olimex's original software.

AVAILABLE DEMO SOFTWARE

[Microchip TCP-IP Stack 5.00 patch](#) modified for PIC-WEB REV.B (will not work without modification on other versions of the stack)

ORDER CODE

PIC-WEB - completely assembled and tested.

How to order?

You can order to us directly or by any of our distributors.

Check our web www.olimex.com/dev for more info.

Revision history:

Board's revision:	REV. B	- created May 2009
Manual's revision	REV. C	- created March 2011
		- added detailed mechanical dimensions

Disclaimer:

© 2010 Olimex Ltd. All rights reserved. Olimex®, logo and combinations thereof, are registered trademarks of Olimex Ltd. Other terms and product names may be trademarks of others.

The information in this document is provided in connection with Olimex products. No license, express or implied or otherwise, to any intellectual property right is granted by this document or in connection with the sale of Olimex products.

Neither the whole nor any part of the information contained in or the product described in this document may be adapted or reproduced in any material form except with the prior written permission of the copyright holder.

The product described in this document is subject to continuous development and improvements. All particulars of the product and its use contained in this document are given by OLIMEX in good faith. However all warranties implied or expressed including but not limited to implied warranties of merchantability or fitness for purpose are excluded.

This document is intended only to assist the reader in the use of the product. OLIMEX Ltd. shall not be liable for any loss or damage arising from the use of any information in this document or any error or omission in such information or any incorrect use of the product.